



CBD COMMUNITY REFERENCE GROUP

MEETING NO. 2

FRIDAY 20 OCTOBER 2017





JOHN HOLLAND EARLY WORKS PROGRAM UPDATE

**METRO TUNNEL
EARLY WORKS**

ACOUSTIC SHED CONSTRUCTION



Indicative Only



Indicative Only

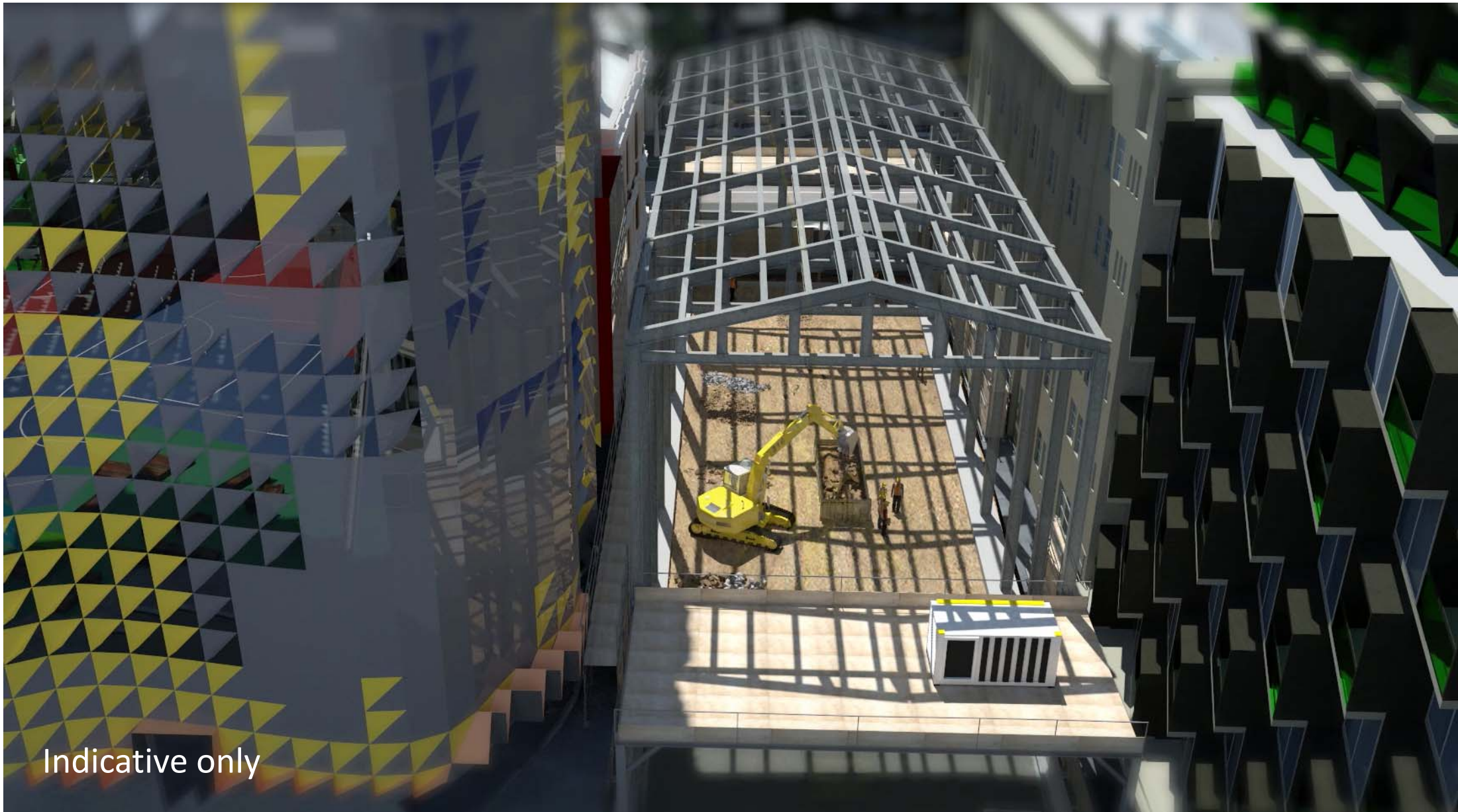

Indicative only



Indicative only



METRO TUNNEL EARLY WORKS

FRANKLIN ST WEST SERVICE RELOCATION

METRO TUNNEL FRANKLIN ST WEST SERVICE RELOCATION

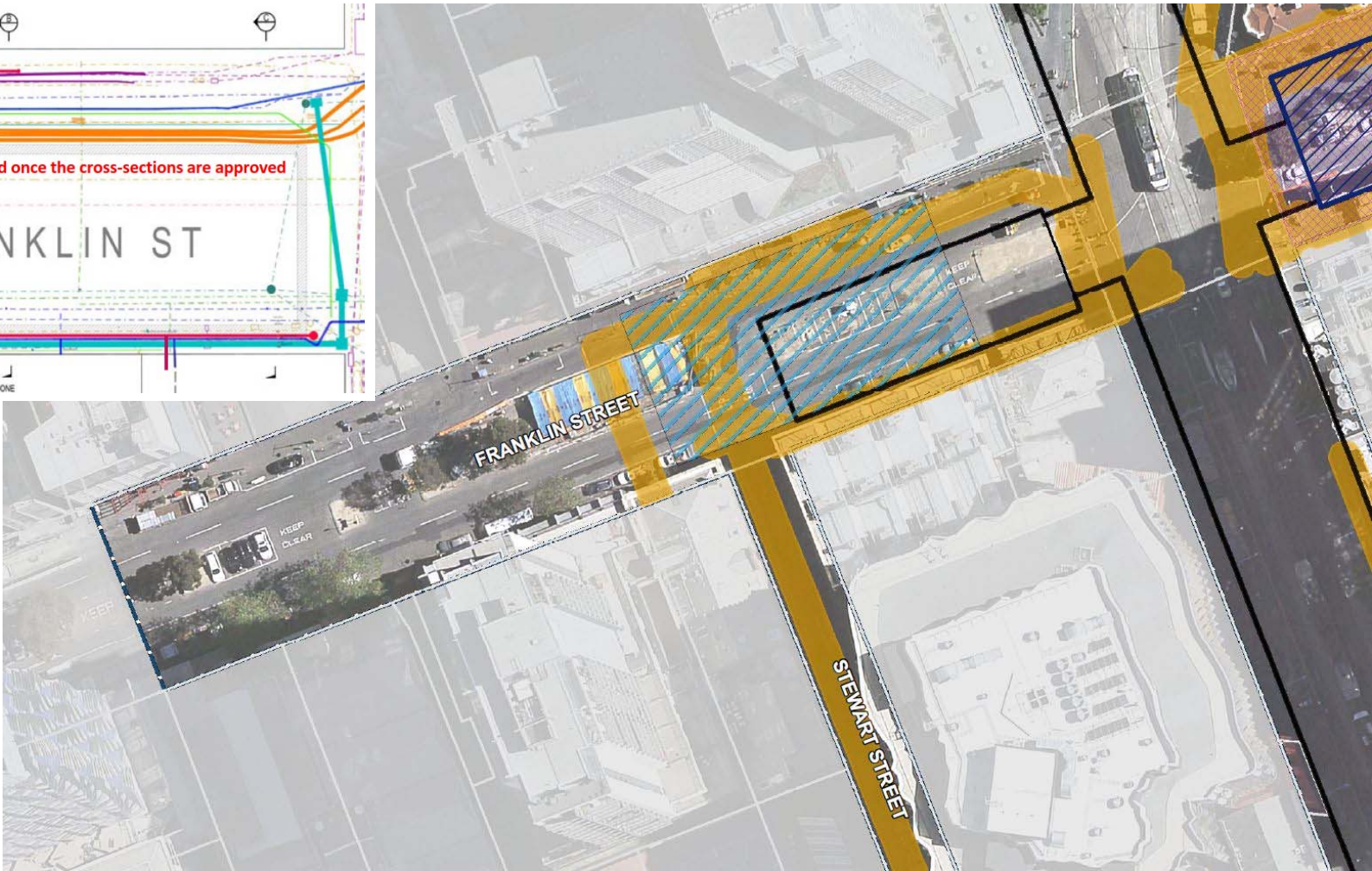
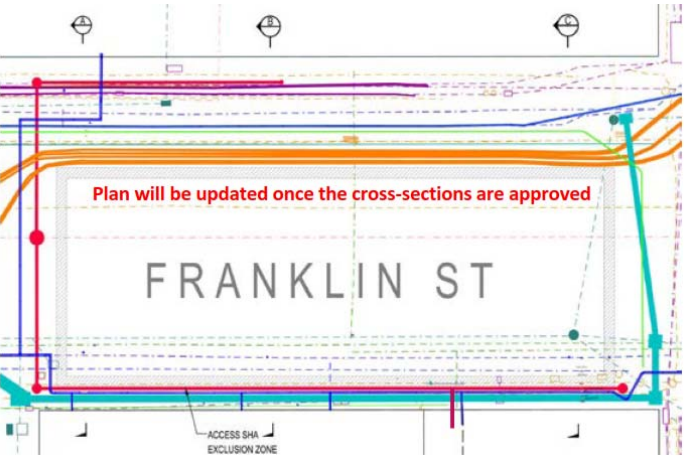

Southern Services – Franklin West

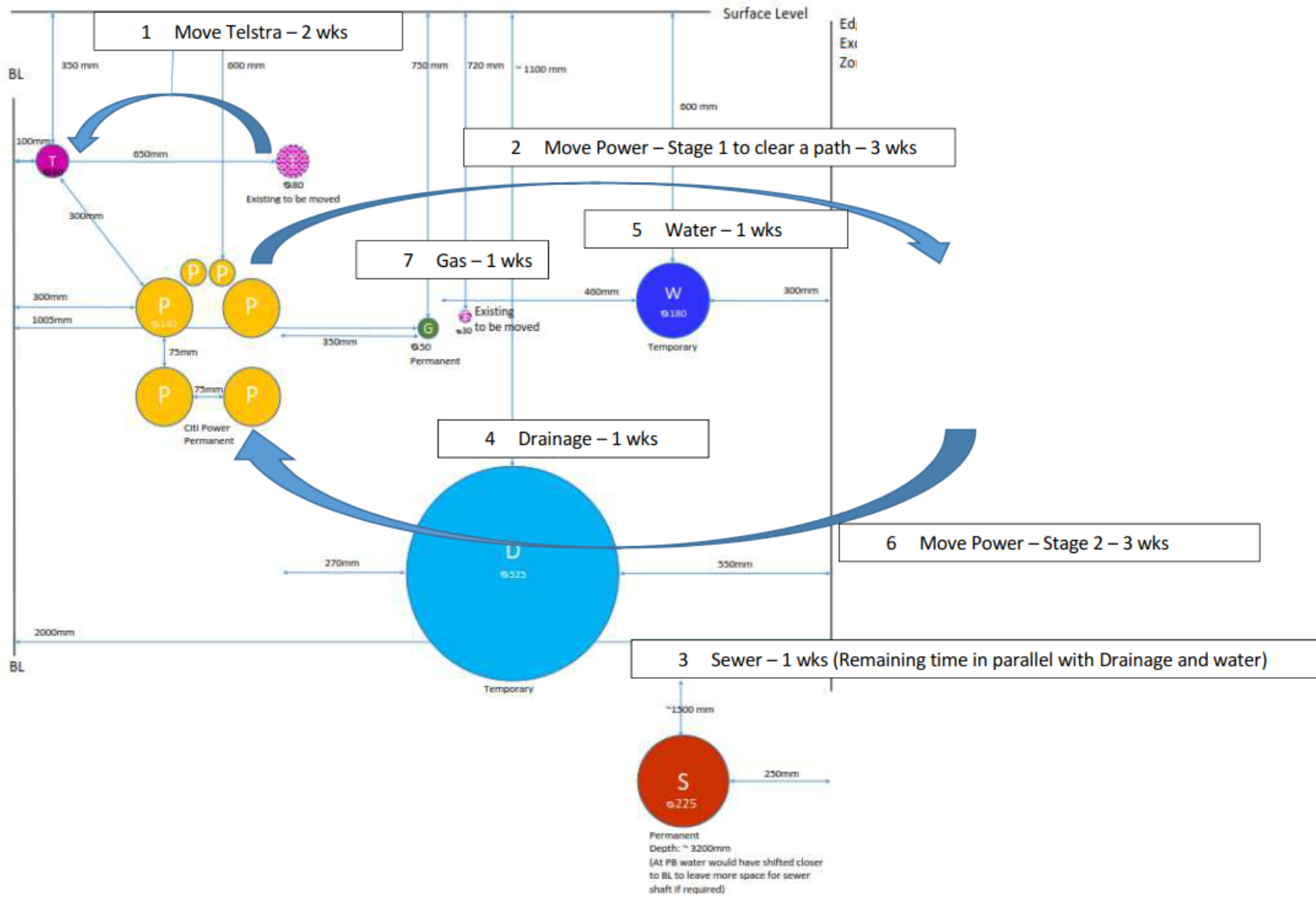

Northern Services – Franklin West

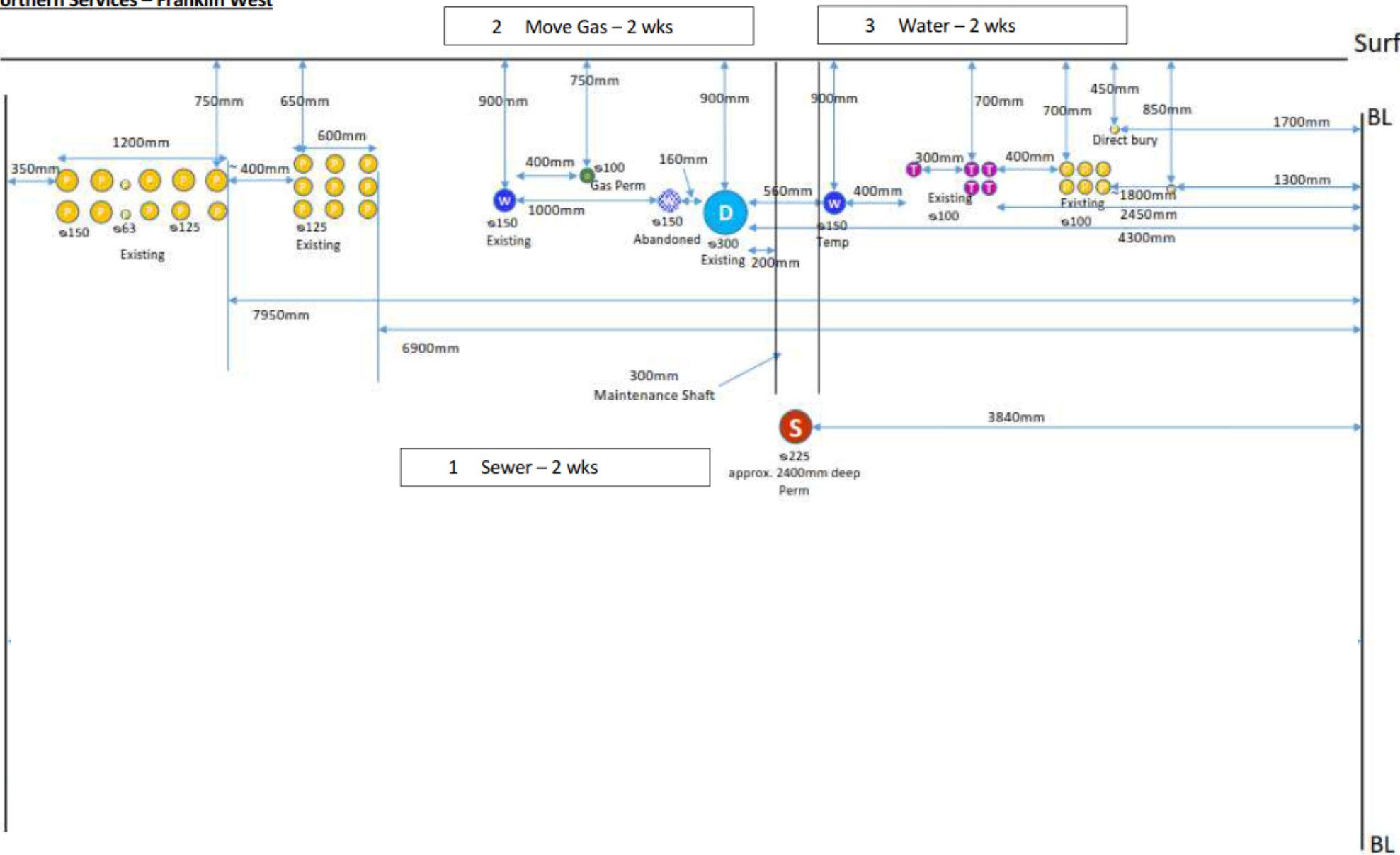

**METRO TUNNEL
EARLY WORKS**

**CITY SQUARE CARPARK
DEMOLITION**



Indicative only

Indicative only and subject to approval

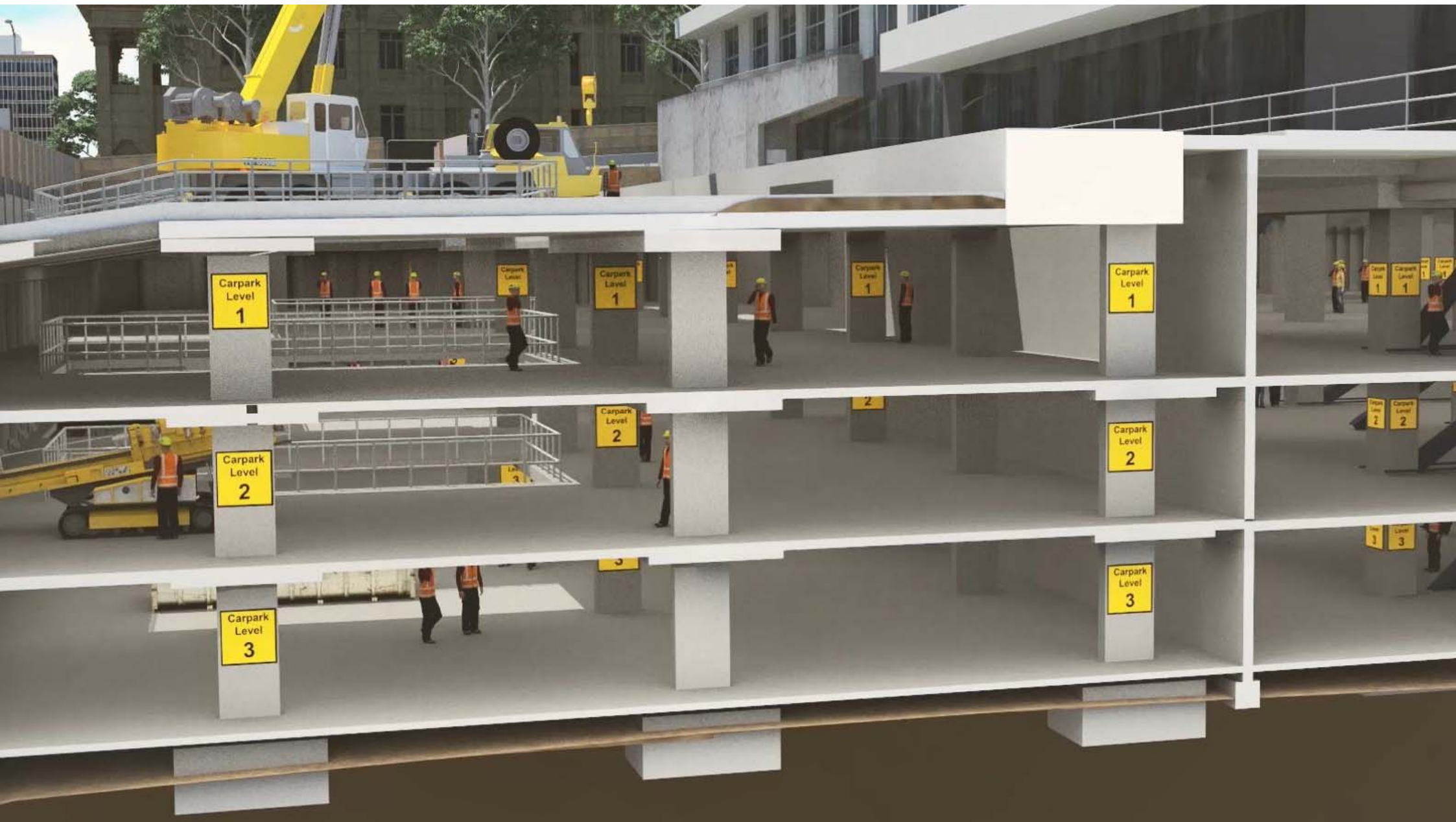





**METRO TUNNEL
EARLY WORKS**

**PORT PHILIP ARCADE
DEMOLITION**

Port Phillip Arcade

- Vacant Possession and arcade closed from 31 Oct 2017
- Service isolation works, HAZMAT removal and soft strip out until the end of 2017
- Hard Demolition works-Jan – Mar 2018

Swanston Street buildings

- Scheduled to be demolished by Dec 2017

Pedestrian access to Flinders Lane and Scott Alley

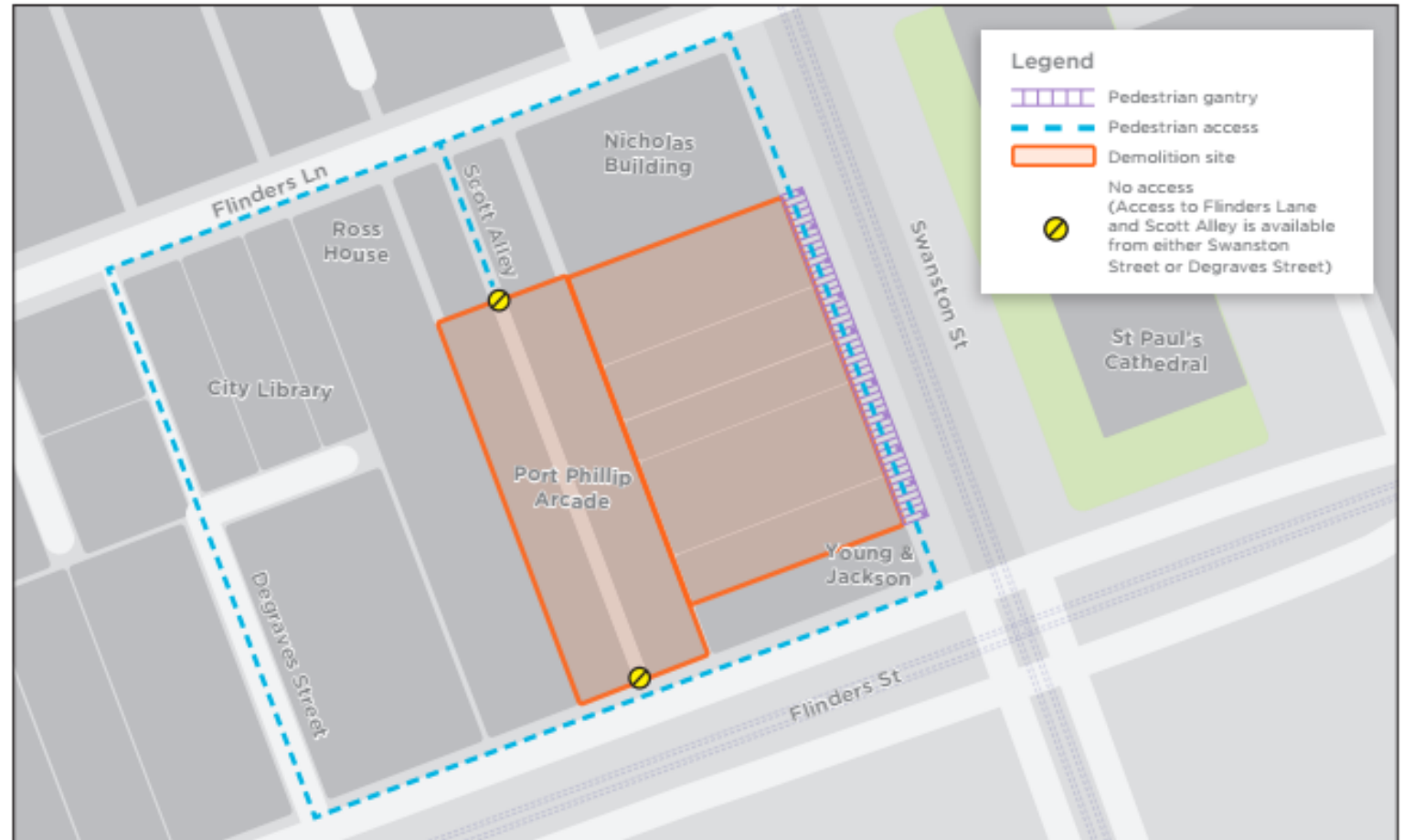

Indicative only

METRO TUNNEL SCOTT ALLEY ACTIVATION



Indicative only and subject to approval



QUESTIONS?